

vtech®

User's Manual

Go! Go! Smart Wheels®
Playtime with miles of learning™

Safe & Sound Rescue City™

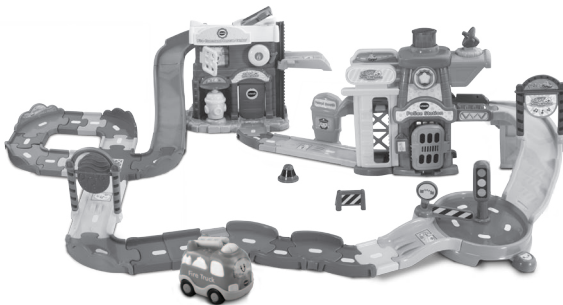

© 2016 VTech
Printed in China
91-003257-000 ©

Dear Parent,

Welcome to the world of **Go! Go! Smart Wheels**®! We're excited you've decided to ride along with us and explore all that **Go! Go! Smart Wheels**® has to offer. These toys have been designed to give your child a thrilling learning experience with hours and hours of fun as well.

Go! Go! Smart Wheels® features vehicles that interact with your child by lighting up, singing and talking, while teaching your child letters and vehicle names (each sold separately). There are other surprises in store, too! With our innovative **SmartPoint**® technology, available on **Go! Go! Smart Wheels**® playsets (each sold separately), your child will smile as they hear **SmartPoint**® vehicles respond to each unique **SmartPoint**® location with singing, sound effects and fun phrases.

Our **Go! Go! Smart Wheels**® playsets also feature buttons, gears and other mechanical features to encourage the development of your child's fine motor skills. Many of the playsets also have tracks that can be arranged in endless ways, stimulating your child's creativity. In addition, all the **Go! Go! Smart Wheels**® playsets connect to other playsets in the collection, so there's no end to what your child can do!

With **Go! Go! Smart Wheels**®, it's playtime with miles of learning™!

Sincerely,
Your friends at **VTech**®

To learn more about **VTech**® toys, visit vtechkids.com

INTRODUCTION

Thank you for purchasing the **VTech® Go! Go! Smart Wheels® Safe & Sound Rescue City™!**

Be a hero with the **Go! Go! Smart Wheels® Safe & Sound Rescue City™!** This bustling playset includes nine SmartPoint® locations, a fire station, a police station, a fire truck and other tracks and accessories to create your own unique city.

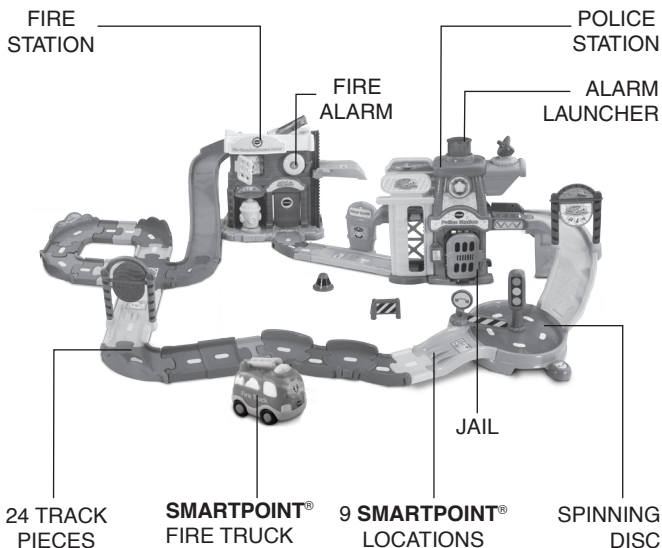

INCLUDED IN THIS PACKAGE

- User's manual
- One sheet of labels



One traffic cone



One roadblock



One small track



One **SmartPoint®**
exit track



One
spinning disc



One big
curved track



One gate



One traffic light



One track support



One large
elevator bracket



One small
elevator bracket



One police
station building



One **SmartPoint®**
police station
elevator



One **SmartPoint®**
patrol booth
track piece



One patrol booth



One **SmartPoint®**
fire truck

INCLUDED IN THIS PACKAGE



One spinner



One gate archway



SmartPoint®
spinning gate track



One fire station building



One fire station base



One **SmartPoint®**
fire station elevator



One fire hydrant



One curved ramp piece



One straight ramp piece



Two 1/4 straight tracks, male



Seven 1/4 straight tracks



One 1/4 straight track, female



Three 90-degree tracks, male

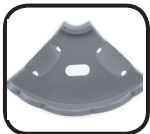

Two 90-degree tracks, female



Two 60-degree track, male



Three 60-degree tracks, female

INCLUDED IN THIS PACKAGE



One cross track



One adjustable track

WARNING:

All packing materials, such as tape, plastic sheets, packaging locks and tags are not part of this toy, and should be discarded for your child's safety.

ATTENTION:

Pour la sécurité de votre enfant, débarrassez-vous de tous les produits d'emballage tels que rubans adhésifs, feuilles de plastique, attaches et étiquettes. Ils ne font pas partie du jouet.

NOTE:

Please keep this user's manual as it contains important information.

UNLOCK THE PACKAGING LOCKS

- ① Turn the packaging lock counter-clockwise several times.
- ② Pull out and discard the packaging lock.

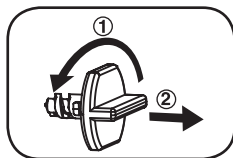

INCLUDED IN THIS PACKAGE

GETTING STARTED

BATTERY INSTALLATION

1. Make sure the unit is turned **OFF**.
2. Locate the battery cover on the bottom of the fire truck. Use a screwdriver to loosen the screw.
3. Install 2 new “AAA” (AM-4/LR03) batteries following the diagram inside the battery box. (The use of new alkaline batteries is recommended for maximum performance.)
4. Replace the battery cover and tighten the screw to secure.

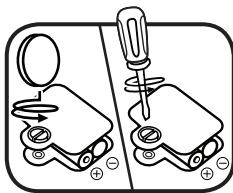

BATTERY NOTICE

- Use new alkaline batteries for maximum performance.
- Use only batteries of the same or equivalent type as recommended.
- Do not mix different types of batteries: alkaline, standard (carbon-zinc) or rechargeable (Ni-Cd, Ni-MH), or new and used batteries.
- Do not use damaged batteries.
- Insert batteries with the correct polarity.
- Do not short-circuit the battery terminals.
- Remove exhausted batteries from the toy.
- Remove batteries during long periods of non-use.
- Do not dispose of batteries in fire.
- Do not charge non-rechargeable batteries.
- Remove rechargeable batteries from the toy before charging (if removable).
- Rechargeable batteries are only to be charged under adult supervision.



Please adhere the labels to the playset as indicated below:



LABEL INSTRUCTIONS

7



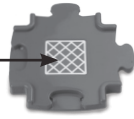
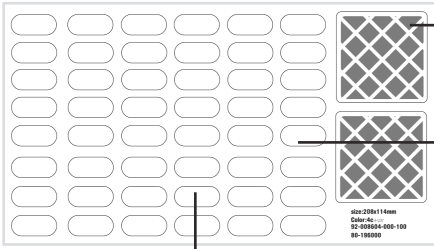

LABEL INSTRUCTIONS



ASSEMBLY INSTRUCTIONS

With the VTech® Go! Go! Smart Wheels® Safe & Sound Rescue City™, safety comes first. To ensure your child's safety, adult assembly is required.

To assemble your Go! Go! Smart Wheels® Safe & Sound Rescue City™ playset, please follow the instructions below:

- 1. Assemble the police station:** First slide the elevator into the groove on the side of the police station building, then attach the large elevator bracket behind the elevator and the small elevator bracket in front. Finally, attach the two brackets to the small track piece to secure.

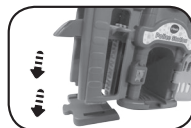
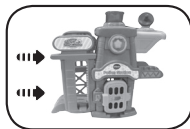
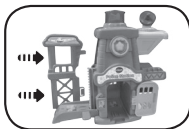

- 2. Assemble the patrol booth:** Attach the patrol booth track to the small track piece on the police station. Then, insert the patrol booth piece onto the notch on the side of the track.

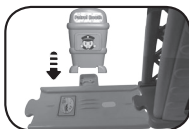

3. **Assemble the curved track:** Attach the track support to the big curved track. Then, attach the curved track to the police station as shown below. Insert the gate into the big curved track.

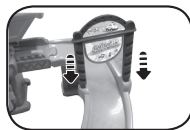
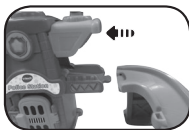

4. **Assemble the spinning disc:** Put the traffic light into the hole at the center of the spinning disc and attach the disc to the bottom of the big curved track. Attach the exit track to the spinning disc.

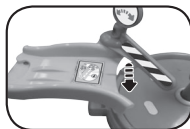

5. **Assemble the spinning gate:** Locate the spinner and insert it into the gate archway as shown. Place the fully assembled spinning gate onto the spinning gate track piece.

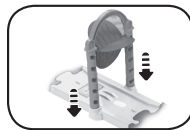

6. **Assemble the fire station:** Slide the elevator onto the groove on the side of the fire station building. Then, attach the fire station building to the station base as shown.



7. **Attach the fire hydrant:** Attach the fire hydrant to the fire station base as shown. You will hear a “click” sound when it locks into place.

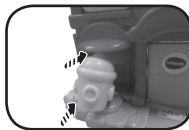

8. **Assemble the ramp:** Connect the curved and straight ramp pieces together. Attach the curved ramp piece to the top of the fire station.

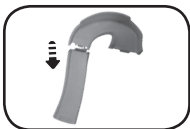



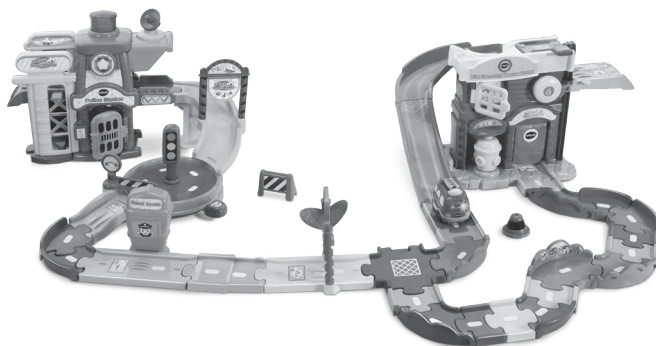
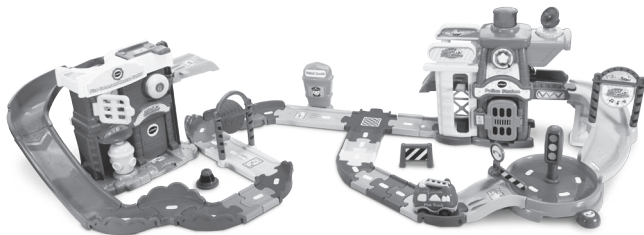

Once you've completed the above steps, you are ready to play! You can connect these pieces to the other included track pieces in a variety of ways.



FIRE TRUCK FEATURES

1. ON/OFF SWITCH

To turn the unit **ON**, slide the **ON/OFF SWITCH** on the fire truck to the **ON** () position. To turn the unit **OFF**, slide the **ON/OFF SWITCH** to the **OFF** () position.

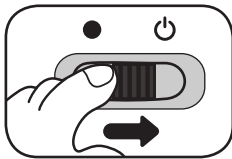

2. AUTOMATIC SHUT-OFF

To preserve battery life, the **VTech® Go! Go! Smart Wheels® Fire Truck** will automatically power-down after approximately 60 seconds without input. The unit can only be turned on again by pressing the light-up button or pushing the fire truck quickly.

NOTE:

This product is in try-me mode in the packaging. After opening the package, turn the vehicle off and on again to proceed with normal play. If the unit powers down while playing, we suggest changing the batteries.

FIRE TRUCK ACTIVITIES

1. Slide the **ON/OFF SWITCH** to turn the unit **ON**. You will hear fire truck sounds, a song and a phrase. The light will flash with the sounds.

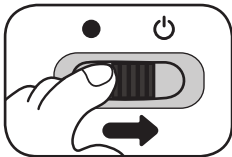

2. Press the **LIGHT-UP BUTTON** to hear fire truck songs and phrases. The light will flash with the sounds.



3. Push the fire truck to hear fun sounds and melodies. While the melody is playing, push the fire truck again to add in fun sounds on top of the melody. The light will flash with the sounds.

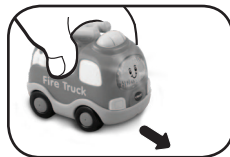

4. For added fun, the fire truck interacts with other **Go! Go! Smart Wheels®** playsets. Simply roll the fire truck over one of the playset's **SmartPoint®** locations to see the fire truck's light flash and to hear greetings, fun sounds and sing-along songs (additional playsets sold separately).

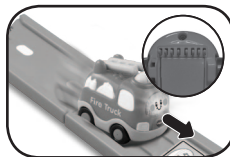

SAFE & SOUND RESCUE CITY™ ACTIVITIES

1. Drive the fire truck over the nine different **SmartPoint®** locations to trigger fun sounds, phrases and sing-along songs.



2. Move the fire truck up to the top of the fire station or police station using the **ELEVATORS**.



3. From the top of the police station, press the **ALARM LAUNCHER** to launch the fire truck down the big curved track.

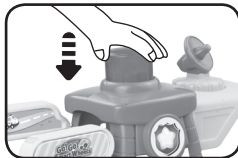

4. Slide the bar on the side of the **SPINNING DISC** to quickly move the fire truck in a fast-paced chase!



5. Open the **JAIL** gate to put the pretend criminal behind bars!



6. Move the fire truck through the spinning gate to watch it twirl.

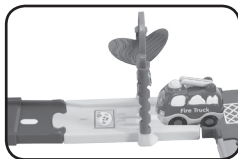

7. Slide the **FIRE ALARM** lever to hear a mechanical alarm sound.



8. Launch the **SmartPoint**® fire truck down the fire station ramp and pretend to race to an emergency!





CARE & MAINTENANCE

1. Keep the unit clean by wiping it with a slightly damp cloth.
2. Keep the unit out of direct sunlight and away from any direct heat source.
3. Remove the batteries when the unit will not be in use for an extended period of time.
4. Do not drop the unit on hard surfaces and do not expose the unit to moisture or water.

TROUBLESHOOTING

If for some reason the unit stops working or malfunctions, please follow these steps:

1. Please turn the unit **OFF**.
2. Interrupt the power supply by removing the batteries.
3. Let the unit stand for a few minutes, then replace the batteries.
4. Turn the unit **ON**. The unit should now be ready to play again.
5. If the product still does not work, replace with a new set of batteries.

If the problem persists, please call our Consumer Services Department at 1-800-521-2010 in the U.S. or 1-877-352-8697 in Canada, or by going to our web site at www.vtechkids.com and filling out our Contact Us form located under the Customer Support link. A service representative will be happy to help you.

IMPORTANT NOTE:

Creating and developing **Infant Learning** products is accompanied by a responsibility that we at **VTech**® take very seriously. We make every effort to ensure the accuracy of the information which forms the value of our products. However, errors sometimes can occur. It is important for you to know that we stand behind our products and encourage you to call our Consumer Services Department on at 1-800-521-2010 in the U.S. or 1-877-352-8697 in Canada, or by going to our web site at www.vtechkids.com and filling out our Contact Us form located under the Customer Support link. A service representative will be happy to help you.





Note:

This equipment has been tested and found to comply with the limits for a Class B digital device, pursuant to Part 15 of the FCC Rules. These limits are designed to provide reasonable protection against harmful interference in a residential installation. This equipment generates, uses and can radiate radio frequency energy and, if not installed and used in accordance with the instructions, may cause harmful interference to radio communications. However, there is no guarantee that interference will not occur in a particular installation. If this equipment does cause harmful interference to radio or television reception, which can be determined by turning the equipment off and on, the user is encouraged to try to correct the interference by one or more of the following measures:

- Reorient or relocate the receiving antenna.
- Increase the separation between the equipment and receiver.
- Connect the equipment into an outlet on a circuit different from that to which the receiver is connected.
- Consult the dealer or an experienced radio/TV technician for help.

Caution: Changes or modifications not expressly approved by the party responsible for compliance could void the user's authority to operate the equipment.

THIS DEVICE COMPLIES WITH PART 15 OF THE FCC RULES. OPERATION IS SUBJECT TO THE FOLLOWING TWO CONDITIONS:
(1) THIS DEVICE MAY NOT CAUSE HARMFUL INTERFERENCE, AND
(2) THIS DEVICE MUST ACCEPT ANY INTERFERENCE RECEIVED, INCLUDING INTERFERENCE THAT MAY CAUSE UNDESIRABLE OPERATION.

CAN ICES-3 (B)/NMB-3(B)

OTHER

18



PRODUCT WARRANTY

This Warranty is applicable only to the original purchaser, is non-transferable and applies only to "VTech" products or parts. This product is covered by a 3-month Warranty from the original purchase date, under normal use and service, against defective workmanship and materials. This Warranty does not apply to (a) consumable parts, such as batteries; (b) cosmetic damage, including but not limited to scratches and dents; (c) damage caused by use with non-VTech products; (d) damage caused by accident, misuse, unreasonable use, immersion in water, neglect, abuse, battery leakage, or improper installation, improper service, or other external causes; (e) damage caused by operating the product outside the permitted or intended uses described by VTech in the owner's manual; (f) a product or part that has been modified (g) defects caused by normal wear and tear or otherwise due to the normal aging of the product; or (h) if any VTech serial number has been removed or defaced.

Prior to returning a product for any reason, please notify the VTech Consumer Services Department by going to our web site at www.vtechkids.com, filling out our Contact Us form located under the Customer Support link or calling 1-800-521-2010.

If the service representative is unable to resolve the issue, you will be provided instructions on how to return the product and have it replaced under Warranty. Return of the product under Warranty must adhere to the following rules: If VTech believes that there may be a defect in the materials or workmanship of the product and can confirm the purchase date and location of the product, we will at our discretion replace the product with a new unit or product of comparable value. A replacement product or parts assumes the remaining Warranty of the original product or 30 days from the date of replacement, whichever provides longer coverage.

THIS WARRANTY AND THE REMEDIES SET FORTH ABOVE ARE EXCLUSIVE AND IN LIEU OF ALL OTHER WARRANTIES, REMEDIES AND CONDITIONS, WHETHER ORAL, WRITTEN, STATUTORY, EXPRESS OR IMPLIED. IF VTECH CANNOT LAWFULLY DISCLAIM STATUTORY OR IMPLIED WARRANTIES THEN TO THE EXTENT PERMITTED BY LAW, ALL SUCH WARRANTIES SHALL BE LIMITED TO THE DURATION OF THE EXPRESS WARRANTY AND TO THE REPLACEMENT SERVICE AS DETERMINED BY VTECH IN ITS SOLE DISCRETION.

To the extent permitted by law, VTech will not be responsible for direct, special, incidental or consequential damages resulting from any breach of Warranty.

This Warranty is not intended to persons or entities outside the United States of America. Any disputes resulting from this Warranty shall be subject to the final and conclusive determination of VTech.

91-003257-000 ©

Register your product online at vtechkids.com/warranty.